

a lex[®] **Modular Conveyors**

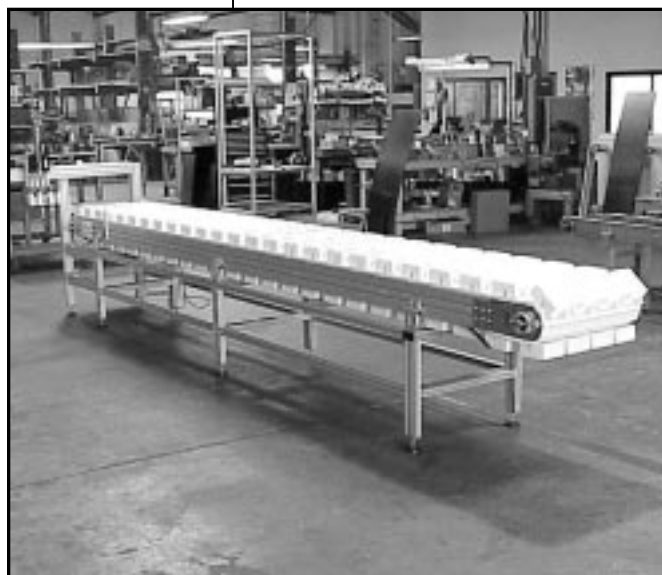
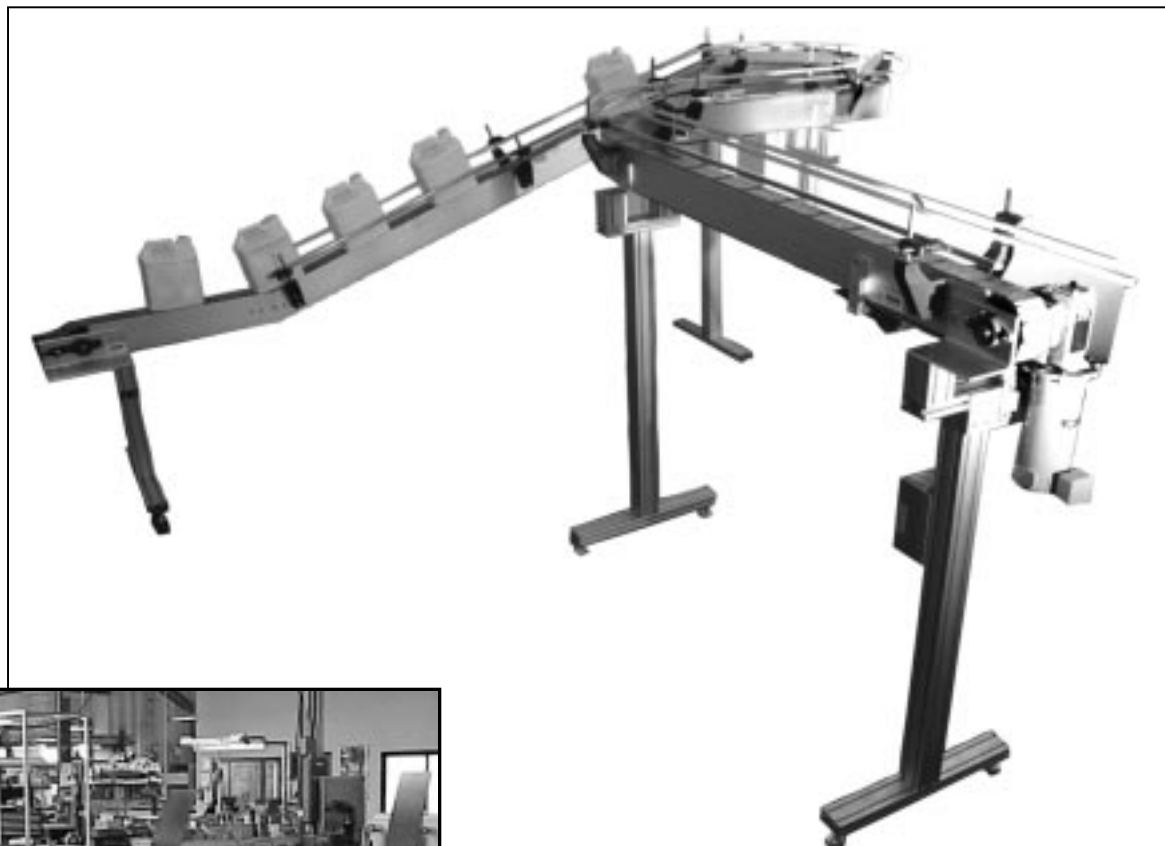

3 Styles

- **Table Top Chain**
- **Mat Top Chain**
- **Belt-Slider Bed**

3 Bed Section Sizes

- **40mm**
- **80mm**
- **140mm**



a lex[®] **Modular Conveyors**

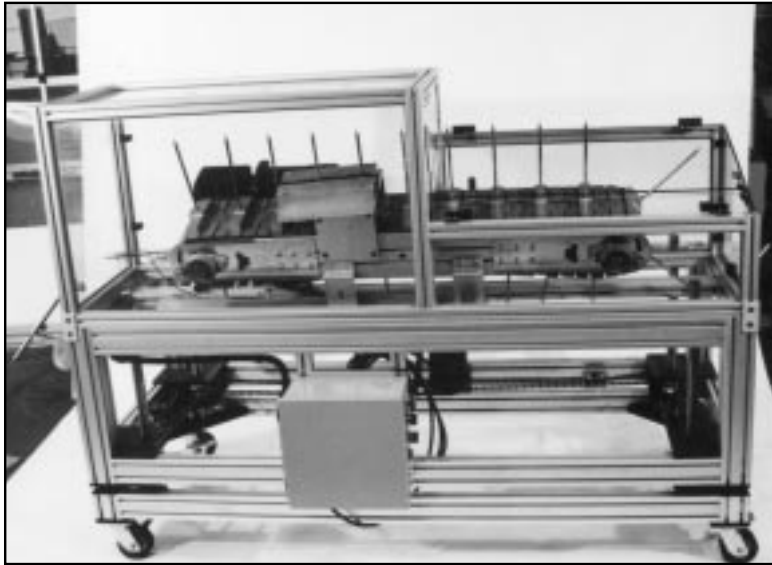

Custom Assembly Conveyor



40mm Series Top Over Application

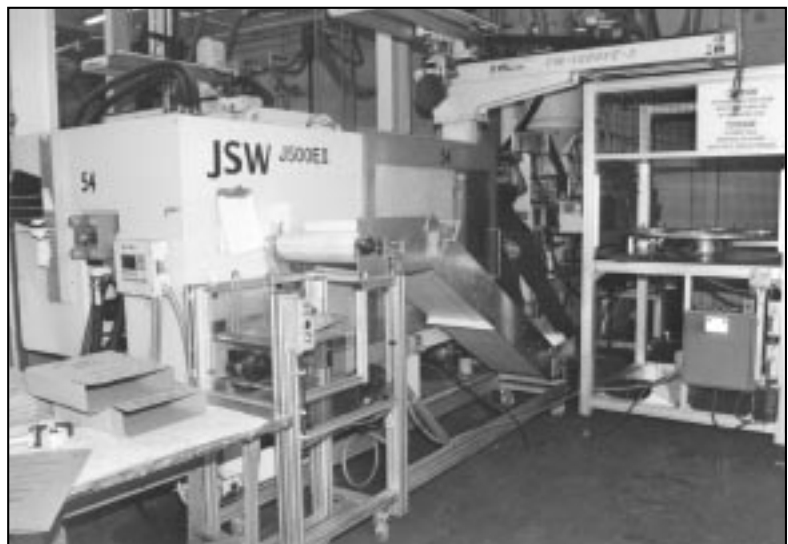

140mm Series Incline Application

a lex[®] **Modular Conveyors**

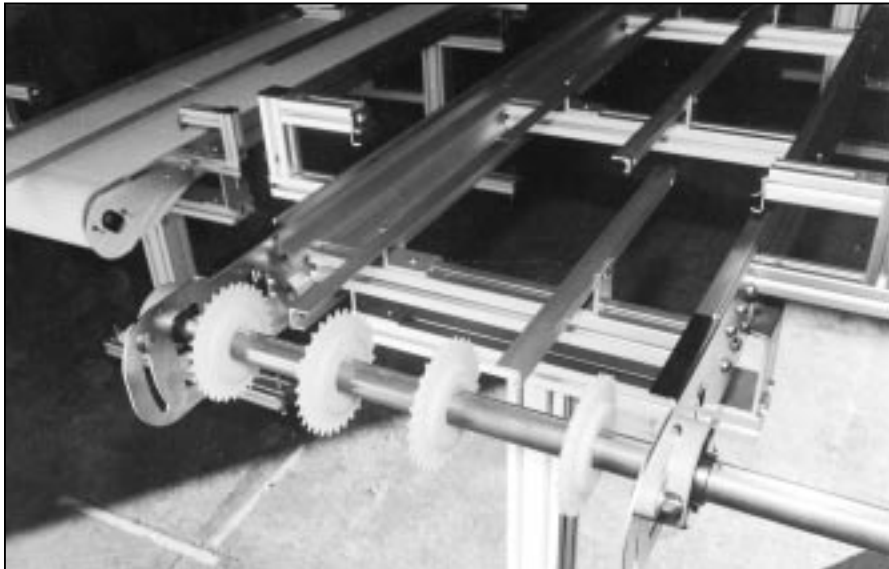

Bed Section Detail



40mm Drive/Idler



40mm Series Conveyor

a lex[®] **Modular Conveyors**

Mat-top Chain Application



Bearings mounted internally

Carousel Application

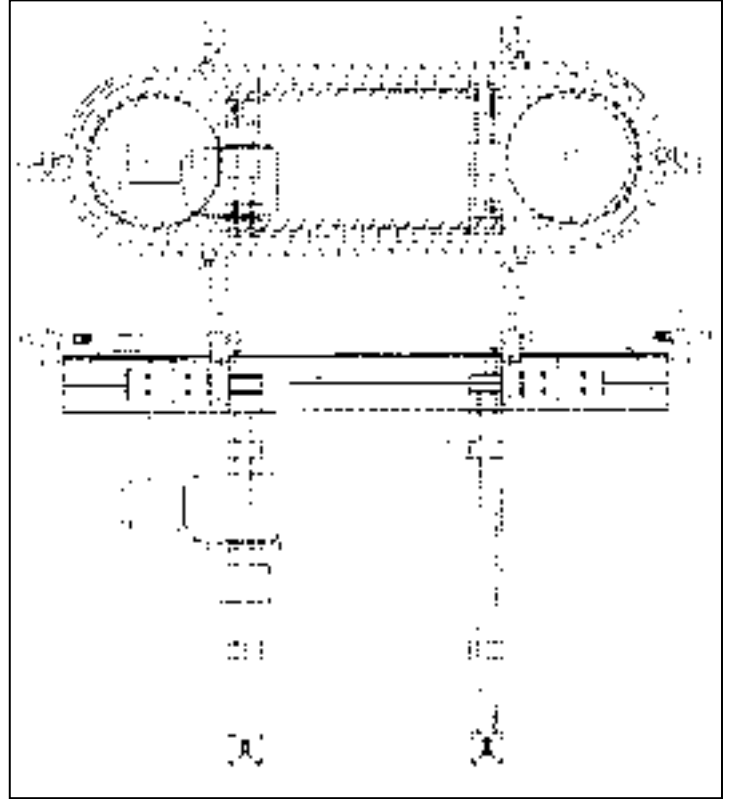

Wide Belt Application



Bearings mounted externally

Inline Application

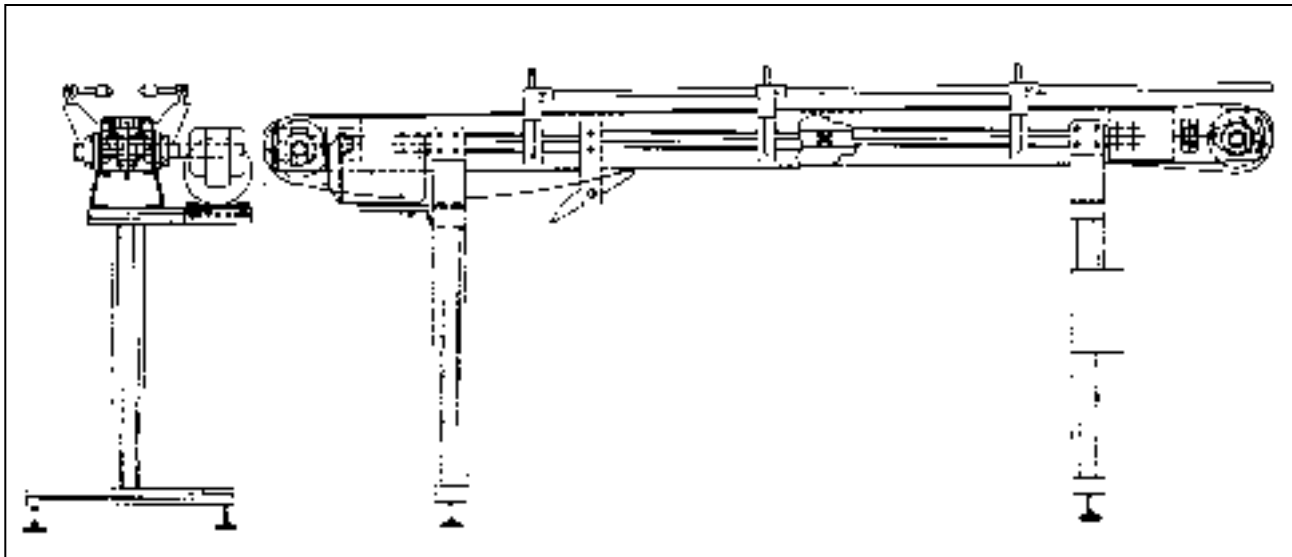

a lex[®] **Modular Conveyors**

Available in three bed section series

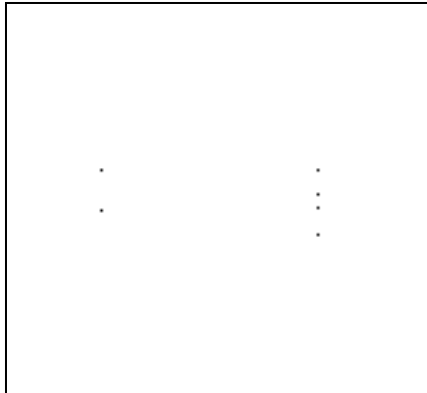

40mm Series

Light duty
Ultra low profile height
Compatible M8 Tslot
mounting
Straight running
configuration only
Wide variety of belts
End or center drive

40mm center spacer bar
Sheetmetal slider bed only
Widths - 1.5" to 36"



80mm Series

Medium duty
Straight running or multi flexing configuration
Compatible M8 Tslot
Belt/table chain/mattop chain suitable
.50 bar stock center spacer bar
Sheetmetal, UHMW rails, roller slider bed
Vertical/horizontal bends
Corner wheels
.75 dia shafting
End drive only

Widths - 3" to 60"

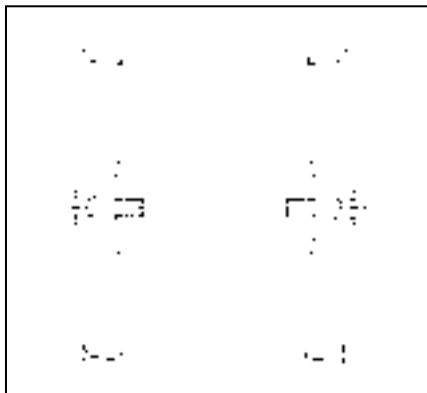

140mm Series

Medium/heavy duty
Straight running or multi flexing configuration
Compatible M8 Tslot
Belt/table chain/mattop chain suitable
40mm profile center spacer bar
Sheetmetal, UHMW rails, roller slider bed
Vertical/horizontal bends
Corner wheels
1.25 dia shafting
End drive only

Widths - 3" to 60"

Conveyors are available three ways:

40mm Series - assembled bed sections only

80mm Series - components/kits/turnkey

140mm Series - components/kits/turnkey

TURNKEY CONVEYORS - simply complete quote check list, include a configuration sketch and fax to the factory.

a lex[®] Conveyor Quote Check List

a lex[®]

products inc

240 w grove ave

orange ca

9 2 8 6 5 - 3 2 0 4

tel 800/85-4-a lex

tel 714/283-1142

fax 714/637-3934

Date: _____

Customer Name: _____

Contact Name: _____

Phone Number: _____

Product: _____

Dimensions: _____ Weight: _____

Conveyor Shape: _____ Straight Length: _____

(Enclose Plan View Sketch)

Elevation Changes: _____ Corner Radius: _____

Width: _____ Chain/Belt Height: _____

Speed: _____

Will product accumulate at any spot? _____

Can product touch? _____

Interface with other equipment? _____

Belt or chain? _____

Guide rails required? _____

Supports? _____

a lex[®] Conveyor Bed Section

40mm Series

- Bed sections are available completely assembled!
- Just add supports/motor/gear box/controller/guidrails as required

Standard sizes - order number sequence

Belt with # [prefix] - OAL length [suffix]

Standard Belt

Width	1.5"	3.0"	4.0"	6.0"	8.0"	10.0"	12.0"	18.0"	24.0"
Prefix #	44637	44638	44639	44640	44641	44642	44643	44644	44645

Order Numbers

OAL Length	Suffix #									
2 FT	-24	44637-24	44638-24	44639-24	44640-24	44641-24	44642-24	44643-24	44644-24	
3 FT	-36	44637-36	44638-36	44639-36	44640-36	44641-36	44642-36	44643-36	44644-36	44645-36
4 FT	-48	44637-48	44638-48	44639-48	44640-48	44641-48	44642-48	44643-48	44644-48	44645-48
5 FT	-72	44637-72	44638-72	44639-72	44640-72	44641-72	44642-72	44643-72	44644-72	44645-72
6 FT	-96	44637-96	44638-96	44639-96	44640-96	44641-96	44642-96	44643-96	44644-96	44645-96
7 FT	-120	44637-120	44638-120	44639-120	44640-120	44641-120	44642-120	44643-120	44644-120	44645-120
8 FT	-144	44637-144	44638-144	44639-144	44640-144	44641-144	44642-144	44643-144	44644-144	44645-144

Custom Configurations are common requests! Contact us!

Standard bed sections include:

- Bed section of 40mm series profiles
- [2] 40mm dia. drive/idler units with tensioners
- 14 GA sheet metal slider bed
- 2-ply belt

All types of belts available:

- Rough top
- Low friction [accumulating]
- Vertical flights

a lex[®] Conveyor Components

Bed Section Profiles Only

80mm Bed Section Profile

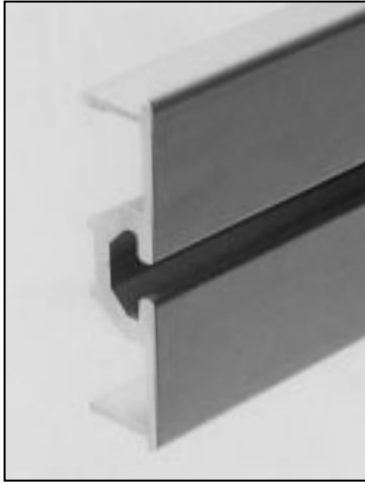

Applications

Single T Slot
Conveyor section
Bendable

Technical Specifications

AL 6063
Clear anodize
 $I = 99.89\text{cm}^4$

Description

80mm section profile
80mm section profile x 6m

Unit

m
Box/8

Part

44448
44449

140mm Bed Section Profile-T Slot

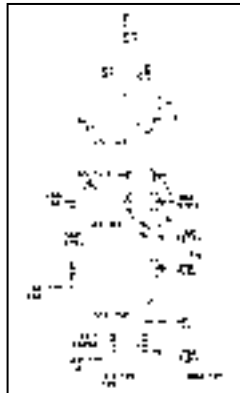

Applications

T-slot wall
Conveyor section
Bendable

Technical Specifications

AL 6063
Clear anodize
 $I = 118.2\text{cm}^4$

Description

T-slot bed section profile
T-slot bed section profile x 6m

Unit

m
Box/8

Part

44270
44271

140mm Bed Section Profile-Plain

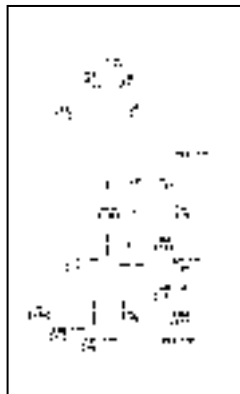

Applications

Smooth wall
Conveyor section
Bendable

Technical Specifications

AL 6063
Clear anodize
 $I = 118.2\text{cm}^4$

Description

Plain bed section profile
Plain bed section profile x 6m

Unit

m
Box/8

Part

44268
44269

a lex[®] Conveyor Components

Conveyor J Leg Profile

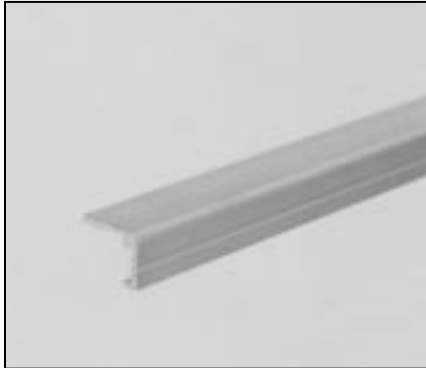

NEW!

Applications

Supports UHMW wearstrips
Use to construct slender beds
and/or side guide rails
Use with 80mm/140mm series only
Compatible with many wearstrip profiles

Technical Specifications

AL6063
Clear anodized

Description

J Leg Profile

Unit

each

Part

44656



Standard Conveyor J Leg Strip



NEW!

Applications

Easily replaceable wear strip
.75" wide

Technical Specifications

UHMW
Black

Description

Std. Wear Strip [10ft pc]
Std. Wear Strip x 10ft

Unit

each
box/16

Part

44272
44273



Lipped Conveyor J Leg Strip



NEW!

Applications

Easily replaceable wear strip
.75" wide
Lipped design for increased
chain containment

Technical Specifications

UHMW
Black

Description

Std. Wear Strip [10ft pc]
Std. Wear Strip x 10ft

Unit

each
box/16

Part

44661
44662



140mm Series J Leg Mounting Bracket



NEW!

Applications

Support J leg profile
for all 140mm series
applications

Technical Specifications

AL 6061
Clear anidize

Description

Std. Wear Strip [10ft pc]
Std. Wear Strip x 10ft

Unit

each
box/16

Part

44661
44662

a lex[®] Conveyor Components

80mm Series Conveyor Bed Section Spacers

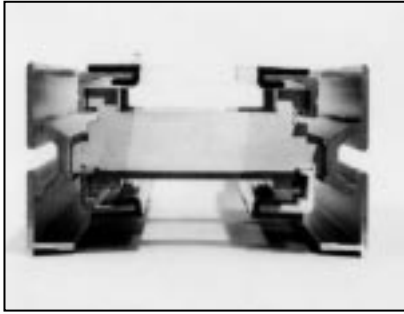

NEW!

Applications

Bed section spacer for use
common table top chain widths

Technical Specifications

al 6061

Description

Spacer for 3.35" chain
Spacer for 4.5" chain
Spacer for 6.0" chain
Spacer for 7.5" chain

Unit

each
each
each
each

Part

44556
44557
44558
44559

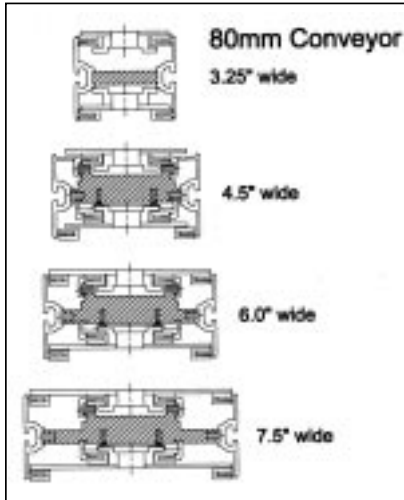

140mm Conveyor Bed Section Spacer Kit

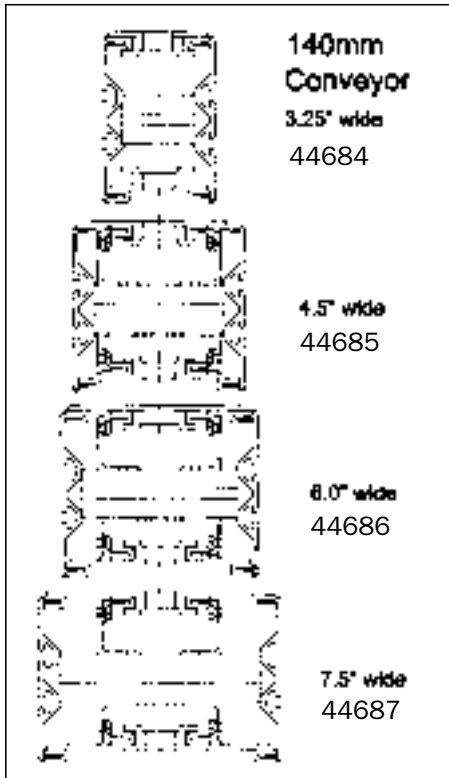

Applications

Bed section spacer kit for use
common table top chain widths

Technical Specifications

#44040 profile
[4] #44542 bracket
[8] M8 FHCS
[8] T slot nuts

Description

Spacer kit for 3.35" chain
Spacer kit for 4.5" chain
Spacer kit for 6.0" chain
Spacer kit for 7.5" chain

Unit

each
each
each
each

Part

44684
44685
44686
44687

a lex[®] Conveyor Components

Horizontal Bends

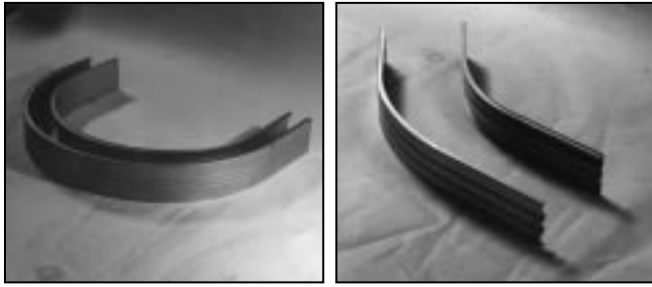

Applications

Both bend sections can be bent (rolled) to suit most common plastic chain minimum radii.

To order, supply the following information by fax or drawing:

- Profile choice
- Centerline radius
- Chain width
- Degree of curve
- Inside/outside bend

(NOTE: - The T-slots MAY become deformed on some small radius bends.)

Description	Unit	Part #
Horizontal bend	ea bend	44281

40mm Incline/Decline Roller Kit

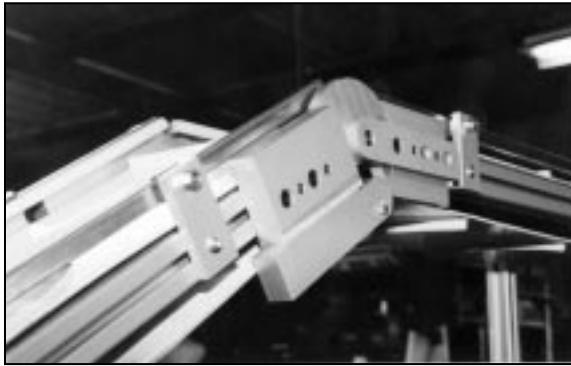

NEW!

Applications

Adjustable angle of either incline or decline of 40mm bed sections
Consult factory for further application information

Technical Specifications

Includes-
side plate
rollers
hardware

Description	Unit	Part #
40mm Incline/Decline Roller Kit	each	44656

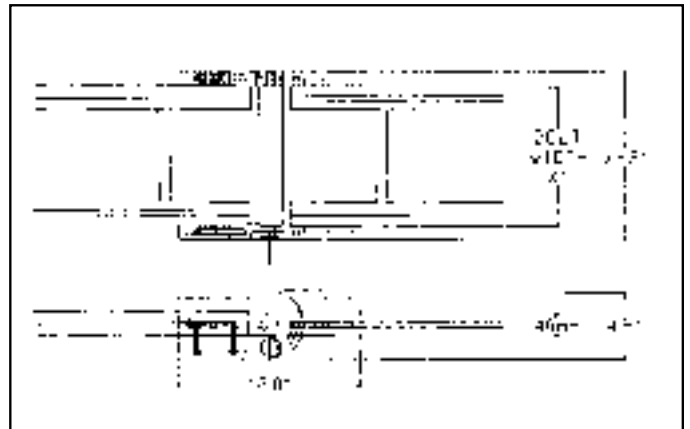

a lex[®] Conveyor Components

80mm Series Vertical Bends

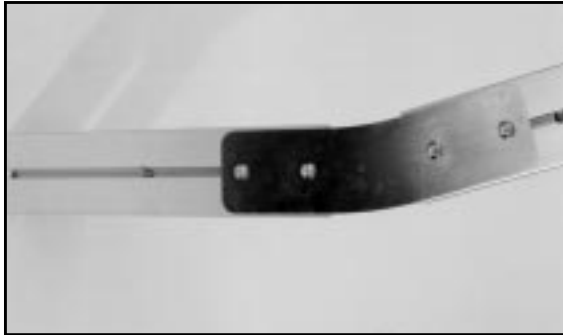

NEW!

Applications

For elevation changes in bed sections

Technical Specifications

crs
Zinc plate

Includes hardware
8-M8 BHCS
8-T Slot Nuts

Description

15° x 80mm vertical bend kit each
30° x 80mm vertical bend kit each
45° x 80mm vertical bend kit each
90° x 80mm vertical bend kit each

Unit

Part

44547
44546
44545
44544

140mm Series Vertical Bends

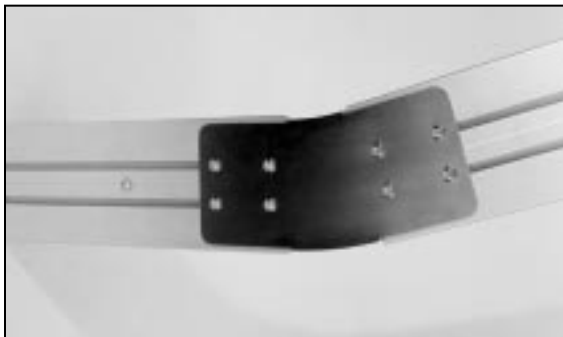

NEW!

Applications

For elevation changes in bed sections

Technical Specifications

crs
Zinc plate

Includes hardware
16-M8 BHCS
16-T Slot Nuts

Description

15° x 140mm vertical bend kit each
30° x 140mm vertical bend kit each
45° x 140mm vertical bend kit each
90° x 140mm vertical bend kit each

Unit

Part

44577
44576
44575
44574

80mm Series Conveyor Drive/Idler Unit



NEW!

Applications

To reverse and guide chain or belt direction
Sealed bearings w/.750 ID
Flange design allows tensioning
Side plate design allows multiple sprocket dia.

Technical Specifications

LH/RH Side plates
SS 304 - Electro polish
Flange bearing - AL6061 T6

Description

80mm Drive/Idler Complete

Unit

Part

each

44450

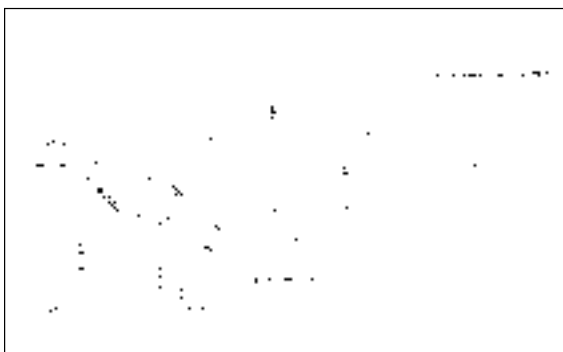

a lex[®] Conveyor Components

140mm Series Motor/Reducer Mount



NEW!

Applications
End mounting of hollow
shaft style gear reducers

Technical Specifications
HRS
Zinc plate

Description	Unit	Part #
140 Series Motor Mount	each	44544

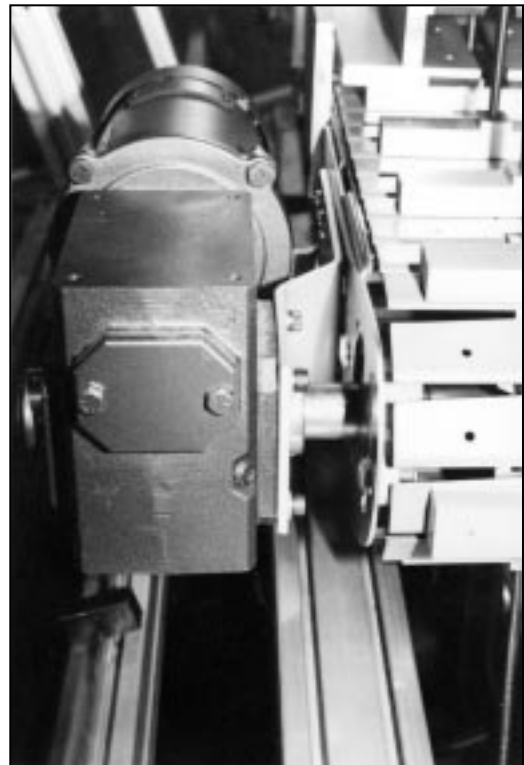
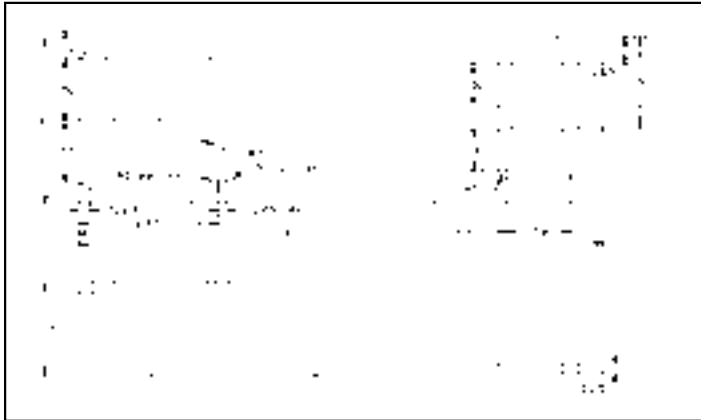

a lex[®] Conveyor Components

Corner Disc Kits - 45, 90, 180 Degree Turns

NEW!

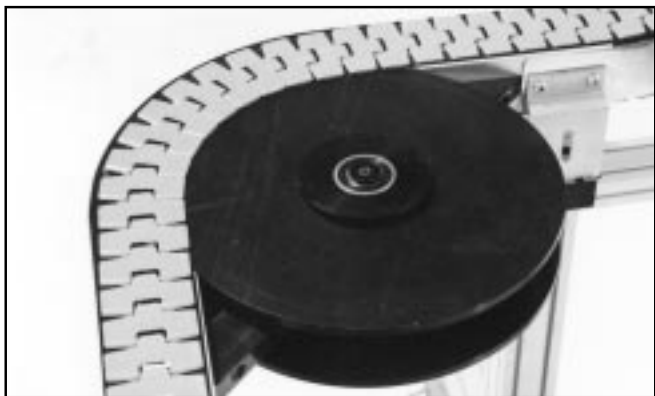

Applications

Tight [200mm] radius corner
for RT series plastic chain
Available for 32.5" & 4.5" widths only

Technical Specifications

Components as shown
Shipped in kit

Description

Unit Part #

For 80mm series conveyors

80mm x 3.25'w x 45° Corner Disc Kit	each	44623
80mm x 4.5'w x 45° Corner Disc Kit	each	44624
80mm x 3.25'w x 90° Corner Disc Kit	each	44625
80mm x 4.5'w x 90° Corner Disc Kit	each	44636
80mm x 3.25'w x 180° Corner Disc Kit	each	44627
80mm x 4.5'w x 180° Corner Disc Kit	each	44628

For 140mm series conveyors

140mm x 3.25'w x 45° Corner Disc Kit	each	44680
140mm x 4.5'w x 45° Corner Disc Kit	each	44681
140mm x 3.25'w x 90° Corner Disc Kit	each	44552
140mm x 4.5'w x 90° Corner Disc Kit	each	44553
140mm x 3.25'w x 180° Corner Disc Kit	each	44683
140mm x 4.5'w x 180° Corner Disc Kit	each	44684

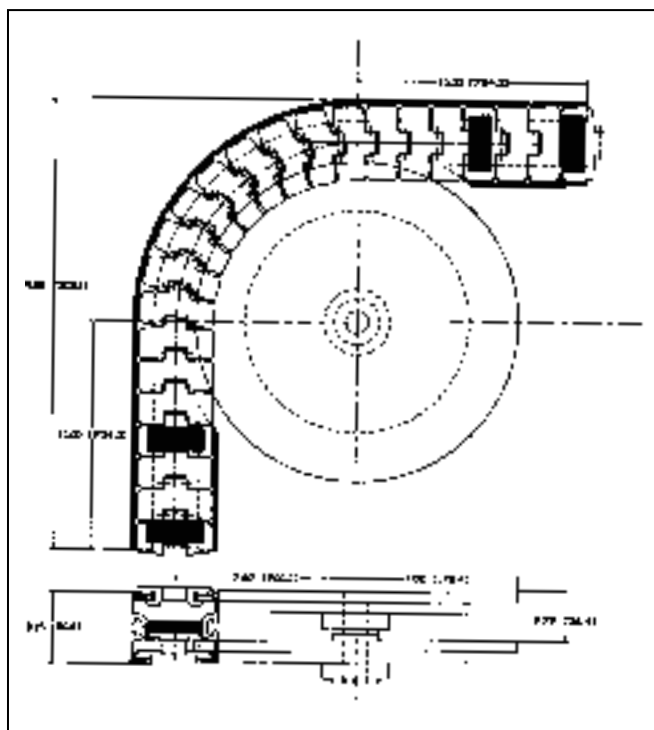

80mm

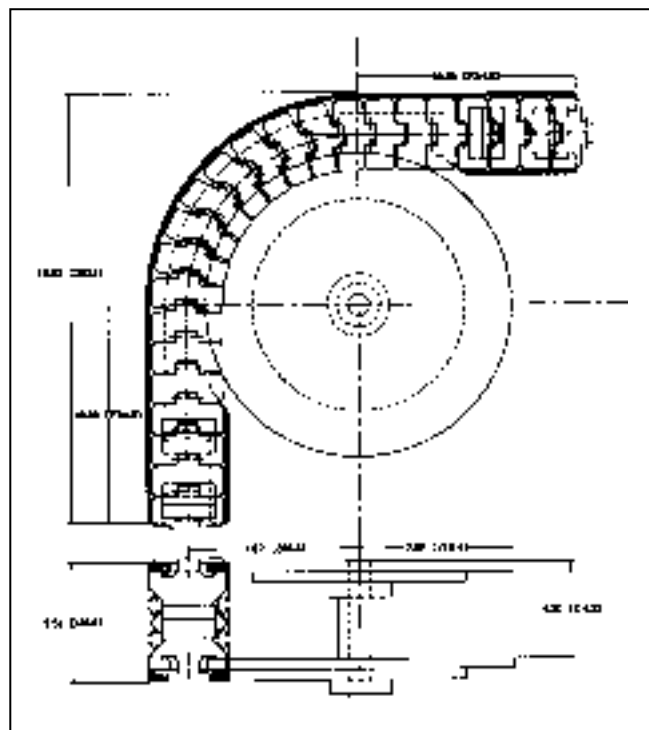

140mm

a lex[®] Conveyor Components

40mm End Motor Drive

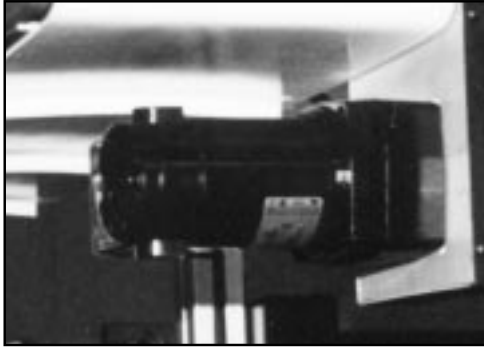

NEW!

Applications

End drive of all types of belts
Includes timing belt & [2] pulleys
Cover
DC motor requires separate controller

Technical Specifications

AC motor
DC motor
1 phase

Description

40mm Series Center Drive
[add belt width suffix - XX]

Unit

Part

With 1/15 hp AC motor - 20FPM	each	44700-XX
With 1/15 hp AC motor - 40FPM	each	44701-XX
With 1/15 hp AC motor - 60FPM	each	44702-XX
With 1/6 hp AC motor - 18FPM	each	44703-XX
With 1/6 hp AC motor - 25FPM	each	44704-XX
With 1/6 hp AC motor - 31FPM	each	44705-XX
With 1/6 hp AC motor - 46FPM	each	44706-XX
With 1/6 hp AC motor - 65FPM	each	44707-XX
With 1/17 hp AC motor - 25FPM	each	44708-XX
With 1/17 hp AC motor - 40FPM	each	44709-XX
With 1/17 hp AC motor - 60FPM	each	44710-XX
With 1/4 hp DC motor - 20FPM	each	44711-XX

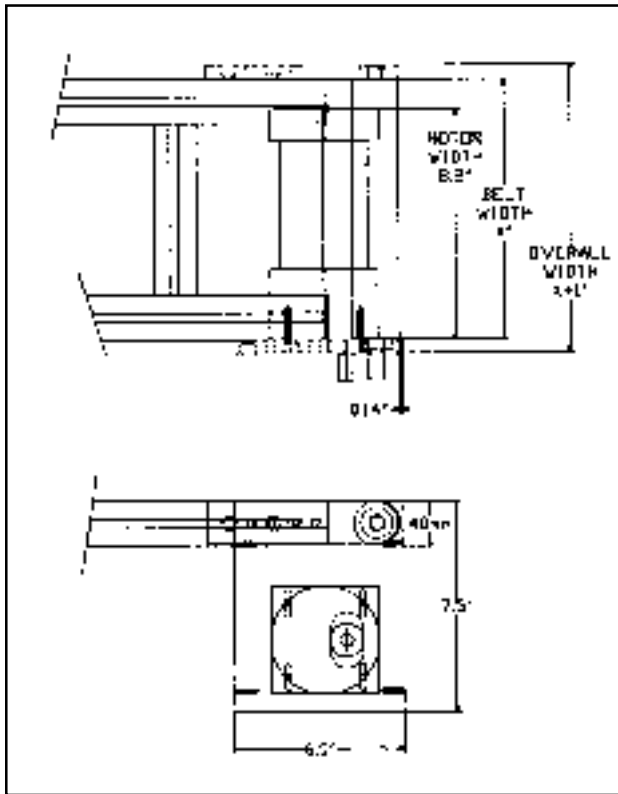

a lex[®] Conveyor Components

40mm Center Motor Drive



NEW!

Applications

End drive of all types of belts
Includes internal belt tensioning

Technical Specifications

AC motor

1 phase 110 VAC

DC motor requires separate controller

Description

40mm Series Center Drive
[add belt width suffix - XX]

Unit

Part

With 1/15 hp AC motor - 20FPM	each	44720-XX
With 1/15 hp AC motor - 40FPM	each	44721-XX
With 1/15 hp AC motor - 60FPM	each	44722-XX

With 1/6 hp AC motor - 18FPM	each	44723-XX
With 1/6 hp AC motor - 25FPM	each	44724-XX
With 1/6 hp AC motor - 31FPM	each	44725-XX
With 1/6 hp AC motor - 46FPM	each	44726-XX
With 1/6 hp AC motor - 65FPM	each	44727-XX

With 1/17 hp AC motor - 25FPM	each	44728-XX
With 1/17 hp AC motor - 40FPM	each	44729-XX
With 1/17 hp AC motor - 60FPM	each	44730-XX

With 1/4 hp DC motor - 20FPM	each	44731-XX
------------------------------	------	----------

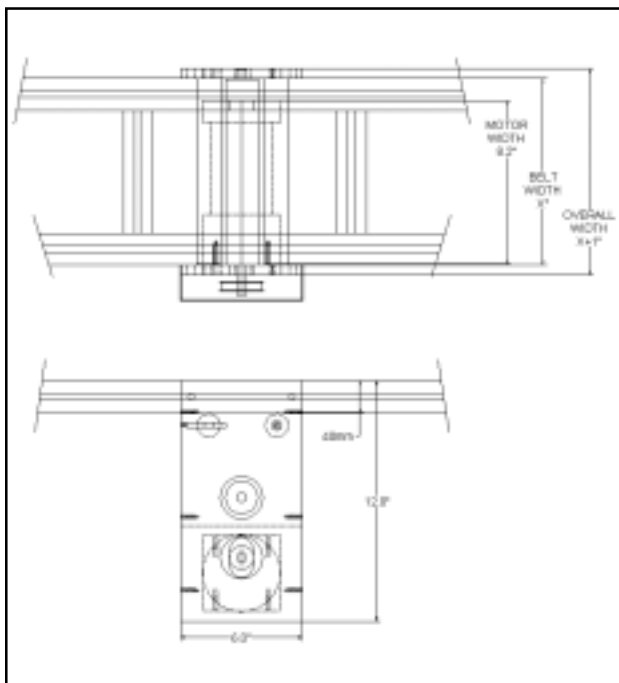

40mm Series Motor Controller

NEW!

Applications

Variable speed DC motor controller
110 VAC input
Enclosure allows remote mounting

Technical Specifications

Description

VDC Controller

Unit

each

Part

44657

a lex[®] Conveyor Components

Supports

Conveyor Support Bracket



Applications

General bed
section support
Design allows for
drip tray clearance

Technical Specifications

AL 6061
Clear anodize

Description

Conveyor support rail

Unit

ea

Part

44312

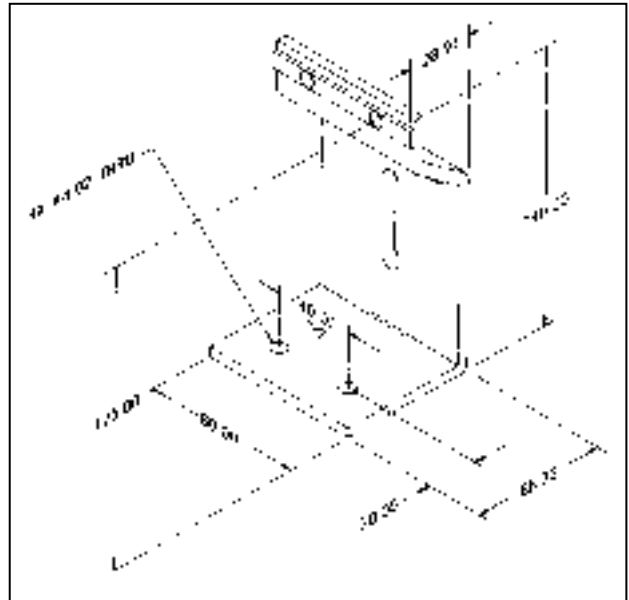

Std I Shaped Support

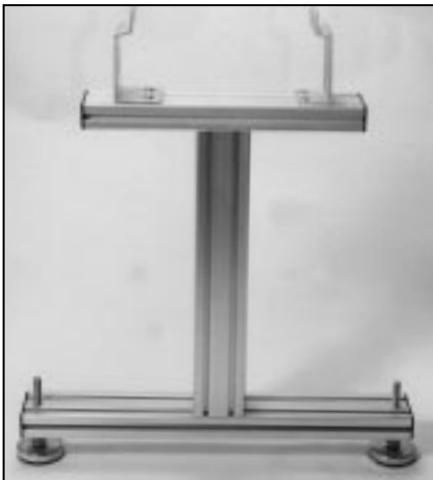

Applications

General Support Base
For all light to medium duty
applications
Sized for approx 34"
chain height (140mm Series)

Technical Specifications

Components as shown
Shipped in Kit form

Description

Std I Shaped support kit

Unit

each

Part

44443

a lex[®] Conveyor Components

Supports

40mm H Support

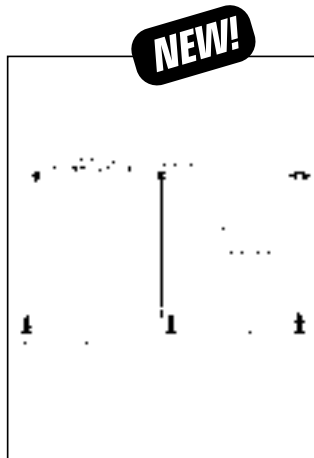

Applications

Light duty H support
Adjustable size design
Max size 24' belt width x
34' belt elevation

Technical Specifications

Components as shown
Shipped in kit

Description

40mm Series H Support Kit

Unit

each

Part

44660

Std H Shaped Support



Applications

General Support Base
For all medium to heavy duty
applications
Sized for approx 34"
chain height (140 Series)

Technical Specifications

Components as shown
Shipped in Kit form

Description

Std H Shaped support kit

Unit

each

Part

44444

Pedestal Base

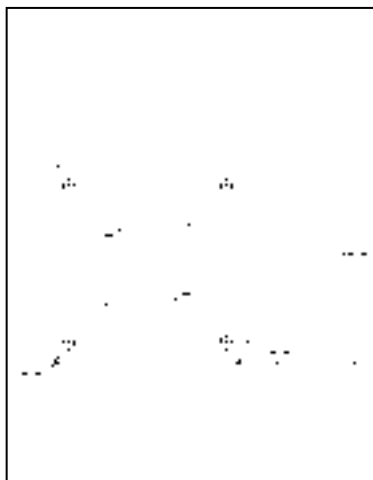

Applications

General Support Base
For all 80x80 leg applications

Technical Specifications

HRS Blk powder coat
Hardware not inc.

Description

Pedestal Base

Unit

each

Part

44453

a lex[®] Conveyor Components

Accessories



Guide Rails - Bull Nose Style



NEW!

Applications

Control of product on conveyor chain
Bull nose shape

Technical Specifications

UHMW
SS backing

Description

Bull nose guide rail

Unit

10' strip

Part

44274

Guide Rails - Flat Bar Style

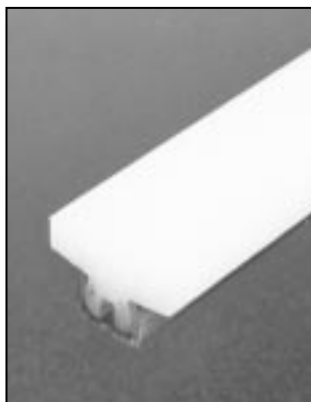

NEW!

Applications

Control of product on belt or chain
Stainless steel backing

Technical Specifications

UHMW

Description

20mm Wide Guide Rail [10ft pcs]
30mm Wide Guide Rail [10ft pcs]
60mm Wide Guide Rail [10ft pcs]
30mm Deep Guide Rail [10ft pcs]

Unit

each
each
each
each

Part

44663
44664
44665
44666

20mm Wide
#44663

30mm Wide
#44664

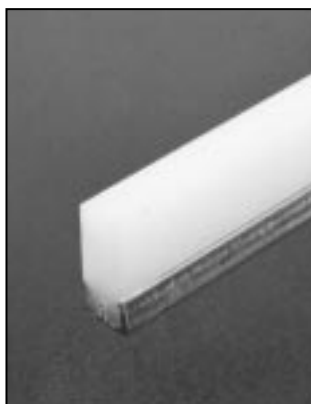

60mm Wide
#44665

30mm Deep
#44666

a lex[®] Conveyor Components

Accessories

Guide Rail Support Kit



NEW!

Applications

Adjustable mounting of
guide rail adjusting rods

Technical Specifications

Material Black Nylon

Description

Guide rail Adj Rod Mount Bracket each

Unit

Part

44278

Profile Guide Rail Mounting Kit

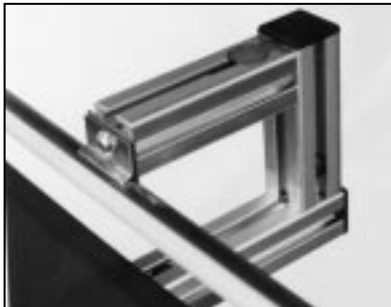

NEW!

Applications

Adjustable mounting of
guide rail adjusting rods
Heavy duty

Technical Specifications

Material 32mm profile
Universal connector

Description

Guide Rail Adj. Rod mount bracket

Unit

each

Part

44524

a lex[®] Conveyor Components

Accessories



Guide Rail Mount Clip



NEW!

Applications

Mounting of single row guide rail wear strips include M8 x BHCS

Technical Specifications

MAT - HRS
Finish - Zinc

Description

Guide Rail Mount Clip

Unit

each

Part

44670



Guide Rail Adjusting Rods



NEW!

Applications

Adjustable mounting of single row guide rail strips

Technical Specifications

Material Shaft - SS
Clip - Nylon

Description

Guide Rail Adjusting Rods - 3" long
Guide Rail Adjusting Rods - 5" long

Unit

each
each

Part

44673
44675



Guide Rail Junction Clip



NEW!

Applications

End to end connection of guide rails
Guide Rail Wear Strips

Technical Specifications

Material

Description

Guide Rail Junction Clip

Unit

each

Part

44669

Std Pallet Base



Applications

General pallet base
Use as a base or machine to suite
80mmx80mm size
Side grooves locates and elevates in one motion
when used w/Std pallet location station

Technical Specifications

UHMW blk

Description

Std Pallet Base

Unit

each

Part

44447

Std Pallet Base Location Station

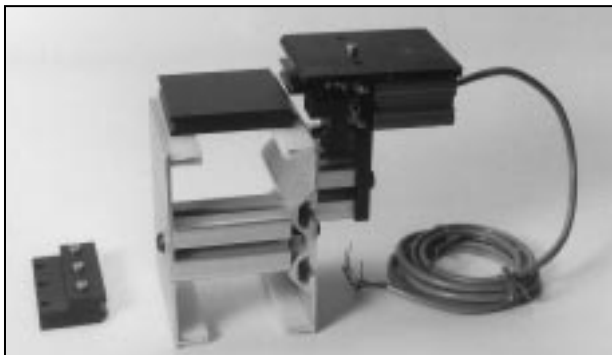

Applications

Use w/ Std pallet base
Provides accurate, rigid positioning
Two cylinder design
One cylinder stops pallet travel
One cylinder lifts and locates std pallet
Design allows use of M12 to M19 thrd sensor
Includes opposite side cam bar

Technical Specifications

Support plates - AL 6061
Blk glass filled nylon
Shaft - 304 SS

Description

Std pallet base location station

Unit

each

Part#

44452

Std Pallet Stop Station

Applications

Use w/ Std pallet base
Halts pallet travel w/one
cylinder design
Design allows use of
M12 to M19 thrd sensor

Technical Specifications

Support plates - AL 6061
Cylinders - 16mm Bors x
25mm stroke
80mm x 40mm Profile spacer
Sensor not included

Description

Std pallet base stop station

Unit

each

Part#

44451

